

UMPQUA Research Company

Analytical Services

FEE SCHEDULE 2019

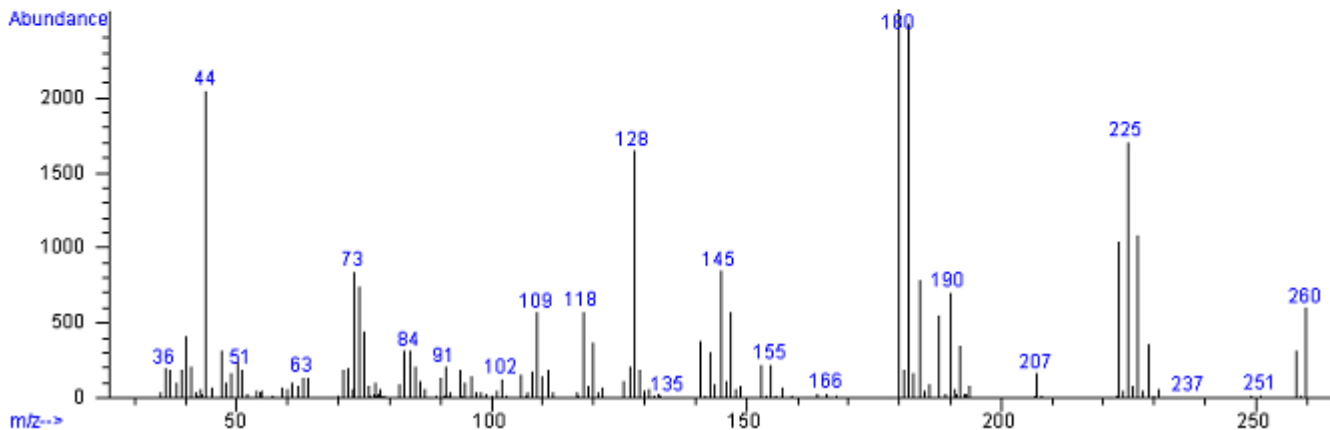
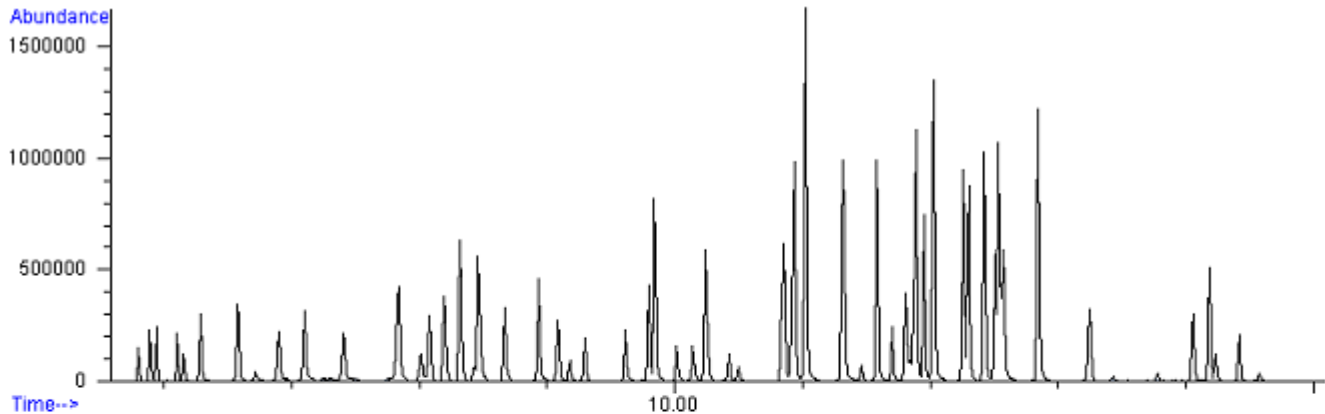

Myrtle Creek

P. O. Box 609, 626 N.E. Division Street
Myrtle Creek, Oregon 97457
Voice: (541) 863-5201
Fax: (541) 863-6199

Web Site – <http://www.umpquaresearch.com>

E-mail – lab@urcmail.net

Bend

738 S.E. Glenwood Drive
Bend, Oregon 97702
Voice: (541) 312-9454
Fax: (541) 312-9456

Web Site – <http://www.umpquaresearch.com>

E-mail – bendlab@urcmail.net

UMPQUA Research Company

LABORATORY SERVICES

"Accurate results, on time, every time"

As the analytical laboratory division of UMPQUA Research Company (URC), we have extensive capabilities in the areas of chemical and microbiological analysis, plus capabilities for specialized or “unusual” analytical requests. Founded in 1973, our locally owned, analytical laboratory is certified in Oregon for the determination of regulated inorganic, organic, and microbial drinking water contaminants, with full capabilities for environmental analyses as well. URC consists of a group of highly trained professionals experienced in chemical and microbial analysis, environmental studies, and engineering research and development. The staff includes chemical, electrical and mechanical engineers, chemists and biological scientists. Our laboratory personnel are active participants in the Oregon Environmental Laboratory Association (OELA). We offer these services to the community at large throughout the Pacific Northwest.

We look forward to serving your Drinking Water and Environmental Analysis needs.

- Our activities are conducted under the auspices of a nationally recognized accreditation body.
- We routinely provide reports in many different formats including specialized QC reports, electronic data transfer, e-mail, faxing, and other customized formats on request.
- The laboratory utilizes a commercial Laboratory Information Management System (LIMS) for sample tracking, record keeping, and data management, which enables us to provide fast, accurate results.

Our analytical lab originated to provide critical support for our parent research company, which specializes in the development of novel forms of analytical instrumentation and new technologies for air and water purification, solid waste treatment, disinfection, and sterilization. Funding for our research and development is primarily from NASA and major aerospace firms, in addition to the National Institutes of Health, the National Science Foundation, and the Departments of Energy and Defense. We continually strive for the highest levels of quality and client satisfaction. Though we have a complete complement of analytical instrumentation, we realize that our primary strength is in our people.

- Every Space Shuttle that ever flew used our technology for on-board disinfection of drinking water.
- Before every space walk American astronauts use our technology to prepare their portable life support systems.
- We are the designers of the primary water purification system for the International Space Station.

TABLE OF CONTENTS

Foreword	i
Table of Contents	ii
Individual Analyte Pricing	1
Discount Drinking Water Packages	2
Regulated Drinking Water Analysis	
Coliforms	3
Disinfection By-Products	3
Inorganic Chemicals (IOCs).....	4
Synthetic Organic Chemicals (SOCs)	4
Volatile Organic Chemicals (VOCs).....	5
Radiochemicals	5
Environmental Analysis	
Coliforms	6
Environmental SOCs (GCMS) – Individual	6
Volatile Organics	8
Underground Storage Tank (UST) Fuel Residue	8
Storm Water Runoff Services	9
Miscellaneous Testing	
Bottled Water	9
EPA Distilled Water Analysis.....	9
Sludge Analysis.....	9
Toxic Characteristics Leaching Procedure.....	9
Sample Preparation and Clean-up	9
Inorganic Contaminants	10
Rush Analysis Rates / Quantity Discounts.....	10
Special Lab / Field Consulting and Non-routine analysis	10
Quality Assurance / Quality Control	11
Instrumentation	11
Emergency Contact Information	11

Individual Analyte Pricing

Contact Lab Prior to Sampling for Specific Instructions

Acidity (in Volatile Solvents)	\$42.00	Molybdenum (Mo)*	\$32.00
Alkalinity (as CaCO ₃)	\$34.00	Nickel (Ni)*	\$32.00
Aluminum (Al)*	\$32.00	Nitrogen, Ammonia (NH ₃ -N)	\$42.00
Antimony (Sb)*	\$32.00	Nitrogen, Nitrate (NO ₃ ⁻ -N)	\$45.00
Arsenic (As)*	\$32.00	Nitrogen, Nitrite (NO ₂ ⁻ -N)	\$45.00
Asbestos (in Water)	\$539.00	Nitrogen, Nitrate+Nitrite	\$60.00
Asbestos (in Solid)	\$53.00	Nitrogen, Organic	\$65.00
Barium (Ba)*	\$32.00	Nitrogen, Kjeldahl	\$49.50
Beryllium (Be)*	\$32.00	Odor	\$40.00
Bicarbonate/Carbonate Alk	\$40.00	Oil & Grease	\$62.00
Biochemical Oxygen Demand (BOD)	\$56.00	pH	\$20.00
Boron (B)	\$32.00	Phenolics (direct)	\$40.00
Bromate (BrO ₃ ⁻)	\$80.00	Phenolics (extracted)	\$137.00
Bromide (Br ⁻)	\$80.00	Phosphate, Ortho (PO ₄ ³⁻)	\$45.00
Cadmium (Cd)*	\$32.00	Phosphorus, Total	\$45.00
Calcium (Ca)	\$32.00	Potassium (K)	\$32.00
Cation Exchange Capacity	\$75.00	Selenium (Se)*	\$32.00
Chemical Oxygen Demand (COD)	\$43.50	Silica	\$42.00
Chloride (Cl ⁻)	\$32.00	Silver (Ag)*	\$32.00
Chlorate (ClO ₃ ⁻)	\$80.00	Sodium (Na)	\$32.00
Chlorite (ClO ₂ ⁻)	\$80.00	Solids, Fixed (FS)	\$36.00
Chlorine, Residual	\$45.00	Solids, Fixed Dissolved (FDS)	\$40.00
Chromium (Cr)*	\$32.00	Solids, Settleable (SS)	\$20.00
Chromium (Hexavalent)	\$125.00	Solids, Total (TS)	\$30.00
Cobalt (Co)*	\$32.00	Solids, Total Dissolved (TDS)	\$32.00
Color (Color Units)	\$20.00	Solids, Total Suspended (TSS)	\$32.00
Copper*	\$32.00	Solids, Volatile (VS)	\$36.00
Cyanide	\$70.00	Solids, Volatile Suspended (VSS)	\$40.00
Dioxin (2,3,7,8-TCDD)	\$960.00	Specific Conductance	\$20.00
Dissolved Organic Carbon	\$63.00	Specific Gravity (Density)	\$50.00
Dissolved Oxygen	\$20.00	Sulfate (SO ₄ ²⁻)	\$32.00
Flash Point	\$110.25	Tannin-Lignin	\$45.00
Fluoride (F ⁻)	\$32.00	Thallium (Tl)*	\$32.00
Formaldehyde	\$105.00	Titanium (Ti)	\$32.00
Hardness	\$30.00	Total Organic Carbon (TOC)	\$50.00
Hardness, Calculated (includes Ca and Mg)	\$72.00	Turbidity	\$20.00
Iodide (I ⁻)	\$50.00	Vanadium (V)*	\$32.00
Iodine (I ₂)	\$50.00	Zinc (Zn)*	\$32.00
Iron (Fe)*	\$32.00		
Lead (Pb)*	\$32.00		
Magnesium (Mg)	\$32.00		
Manganese (Mn)*	\$32.00		
MBAS	\$185.00		
Mercury (Hg)	\$56.00		

* Special pricing for analysis of multiple metals in one sample.
 3-11 Metals: \$22.40/metal
 12 or more Metals: \$250.00 flat rate

Contact lab prior to sampling for containers and instructions

DISCOUNT DRINKING WATER PACKAGES

Coliform Bacterial Analysis –Total Coliforms/*E. coli*

Weekly Samples	\$22
Monthly Samples	\$30
Quarterly Samples	\$36
Regular Samples.....	\$40

New Well Package – Nitrate, Arsenic, Total Coliforms/*E.coli*, pH, and Conductivity \$136

Real Estate Package – Nitrate, Arsenic, and Total Coliforms/*E.coli* (Call before sampling) \$110

Lead & Copper \$45

Diagnostic Package: pH, Specific Conductance, Hardness, Iron, Turbidity, and Total Suspended Solids (TSS)

\$115

General Package: Specific Conductance, Nitrate, Chloride, Lead, Arsenic, Iron, Hardness, and Total Coliforms/*E. coli*.....

\$210

Corrosion Package: Alkalinity, Specific Conductance, Total Dissolved Solids (TDS), pH, Calcium, Lead, Copper, Zinc, and Corrosivity (Langelier Index).....

\$210

Complete Package: Diagnostic and General Packages plus Cadmium, Chromium, Copper, Nickel, Sodium, Thallium, Zinc, and Fluoride

\$325

Regulated Inorganic Contaminants (IOC): Antimony, Arsenic, Barium, Beryllium, Cadmium, Chromium, Cyanide, Fluoride, Lead, Mercury, Nickel, Nitrate, Nitrite, Selenium, and Thallium

\$369

Oregon/Washington Primary: Arsenic, Barium, Cadmium, Chromium, Fluoride, Lead, Mercury, Nitrate, Selenium, and Silver.....

\$195

Oregon & National Secondary: Alkalinity, Aluminum, Calcium, Chloride, Color, Copper, Corrosivity (Langelier Index), Fluoride, Hardness, Iron, Manganese, MBAS, Odor, pH Silver, Specific Conductance, Sulfate, TDS, Total Solids (TS), and Zinc.....

\$425

Complete Phase II and V* – IOCs, SOCs, and VOCs (Regulated & Unregulated) \$1565

***Except Asbestos & Dioxin**

REGULATED



DRINKING WATER ANALYSIS

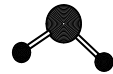

Under the authority of the Safe Drinking Water Act, the U.S. Environmental Protection Agency (EPA) mandates the routine analysis of all public water supplies to determine if any potentially hazardous contaminants are present and, if so, in what concentration. UMPQUA Research is accredited by the State of Oregon (ORELAP Approved Laboratory #100031 (Myrtle Creek) and #100052 (Bend)), in accordance with the National Environmental Laboratory Accreditation Program (NELAP) to perform these services.

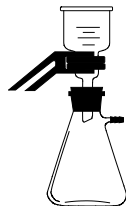

Microbiology

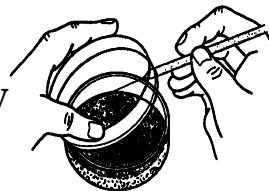

Total Coliforms / Fecal Coliforms	Method	Price
Colilert (Total Coliform & <i>E. coli</i>) P/A	SM 9223 B	\$40.00
Fermentation Technique (Total & Fecal Coliform) P/A....	SM 9221 A,B,C,E	\$50.00
Heterotrophic Plate Count.....	SM 9215 B	\$52.50
Detergent & Inhibitory Residue	SM 9020 B	\$240.00
Distilled Water Suitability	SM 9020 B	\$285.00

Disinfection / Disinfection By-Products

Most community water systems control the growth of microorganisms by the addition of chlorine. A byproduct of chlorination is the formation of toxic compounds by the reaction of chlorine with naturally occurring dissolved organic compounds. These are called Disinfection By-Products, the most common of which are Trihalomethanes.

Residual Chlorine	\$45
Total Chlorine	\$60
Chlorine Dioxide	\$60
Chloramines	\$75

Trihalomethanes, Total (TTHMs) – EPA 524.2

Bromoform, Chloroform, Bromodichloromethane, Chlorodibromomethane	\$130
---	--------------

Haloacetic Acids – SM 6251B	\$200
--	--------------

Anions – EPA 300.1:

Bromate	\$80
Chlorite.....	\$80



Inorganic Chemicals (IOCs)

Inorganic Chemicals (IOCs) are regulated compounds that can be naturally present in your water source. Some are toxic heavy metals such as Arsenic, Lead, and Mercury; others are non-metallic ions such as Cyanide, Fluoride, or Nitrate. The package below is the complete IOC listing except asbestos. Prices for individual inorganics are summarized on Page 1.

IOCs - Antimony, Arsenic, Barium, Beryllium, Cadmium, Chromium, Cyanide, Fluoride, Lead, Mercury, Nickel, Nitrate, Nitrite, Selenium, and Thallium.....\$369

Synthetic Organic Chemicals (SOCs)

Synthetic Organic Chemicals (SOCs) are man-made carbon containing substances such as pesticides, herbicides, and solvents. These are generally not very soluble in water, but may be present at very low levels.

Synthetic Organic Chemicals \$1150

Regulated	Dibromochloropropane	Pentachlorophenol	Butachlor
2,4-D	Dinoseb	Picloram	Carbaryl
2,4,5-TP (Silvex)	Diquat	PCB's	Dicamba
Bis(2-ethylhexyl)adipate	Endothall	Simazine	Dieldrin
Bis(2-ethylhexyl)phthalate	Endrin	Toxaphene	Methomyl
Alachlor (Lasso)	Ethylene dibromide (EDB)	Oxamyl (Vydate)	Metolachlor
Atrazine	Glyphosate	Unregulated	Metribuzin
Benzo(a)pyrene	Heptachlor	3-Hydroxycarbofuran	Propachlor
γ -BHC (Lindane)	Heptachlor epoxide	Aldicarb	
Carbofuran	Hexachlorobenzene	Aldicarb sulfoxide	
Chlordane	Hexachlorocyclopentadiene	Aldicarb sulfone	
Dalapon	Methoxychlor	Aldrin	

EPA Method 504.1: Ethylene dibromide (EDB), Dibromochloropropane (DBCP)\$125

EPA Method 508.1 - Chlorinated Pesticides: Chlordane, Toxaphene, PCBs – Aroclor ID\$195

EPA Method 515.4 - Chlorinated Organic Acids: 2,4-D; 2,4,5-TP (Silvex); Dalapon; Dicamba; Dinoseb; Pentachlorophenol; Picloram.....\$210

EPA Method 525.2\$295

Alachlor (Lasso)	Bis(2-ethylhexyl)adipate	Heptachlor	Metolachlor
Aldrin	Bis(2-ethylhexyl)phthalate	Heptachlor epoxide	Metribuzin
Atrazine	Butachlor	Hexachlorobenzene	Propachlor
γ -BHC (Lindane)	Dieldrin	Hexachlorocyclopentadiene	Simazine
Benzo(a)pyrene	Endrin	Methoxychlor	

EPA Method 531.1: Carbamate pesticides:\$185

Aldicarb	Carbaryl	Methomyl
Aldicarb sulfone	Carbofuran	Oxamyl (Vydate)
Aldicarb sulfoxide	3-Hydroxycarbofuran	

EPA Method 547: Glyphosate (Roundup).....\$150

EPA Method 548.1: Endothall.....\$235

EPA Method 549.2: Diquat\$185

Volatile Organic Chemicals (VOCs)

Volatile Organic Chemicals (VOCs) are man-made carbon containing substances such as Benzene, Toluene, and Xylenes that evaporate quickly when exposed to air.

Volatile Organic Chemicals - (EPA 524.2).....\$225

<u>Regulated</u>	Toluene	2-Chlorotoluene
Benzene	Total Xylenes	4-Chlorotoluene
Carbon tetrachloride	1,2,4-Trichlorobenzene	Dibromochloromethane
Chlorobenzene	1,1,1-Trichloroethane	Dibromomethane
1,2-Dichlorobenzene	1,1,2-Trichloroethane	1,3-Dichlorobenzene
1,4-Dichlorobenzene	Trichloroethylene	1,1-Dichloroethane
1,2-Dichloroethane	Vinyl chloride	1,3-Dichloropropane
1,1-Dichloroethylene	<u>Unregulated</u>	2,2-Dichloropropane
<i>cis</i> -1,2-Dichloroethylene	Bromobenzene	1,1-Dichloropropene
<i>trans</i> -1,2-Dichloroethylene	Bromoform	<i>cis</i> -1,3-Dichloropropene
1,2-Dichloropropane	Bromodichloromethane	<i>trans</i> -1,3-Dichloropropene
Ethylbenzene	Bromomethane	1,1,1,2-Tetrachloroethane
Methylene chloride	Chloroethane	1,1,2,2-Tetrachloroethane
Styrene	Chloroform	1,2,3-Trichloropropane
Tetrachloroethylene	Chloromethane	

Radiochemicals

Radiochemicals are natural or man-made substances that are *radioactive*. These materials are unstable and emit *alpha*, *beta*, and/or *gamma* radiation as they decompose.

Gross Alpha Radiation EPA 900.0 \$110

Gross Alpha & Gross Beta EPA 900.0 \$155

Radium 226 & 228..... E903.0 & RA-05/Calculation..... \$315

Uranium EPA 200.8 \$56

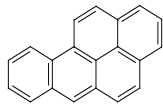
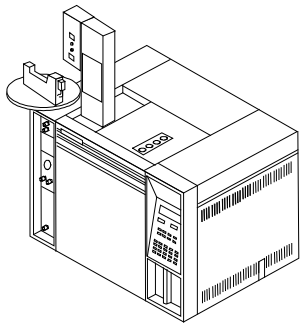

ENVIRONMENTAL ANALYSIS

UMPQUA Research Company – Analytical Services Laboratory, is an active participant in the Oregon Environmental Laboratory Association (OELA). We perform analyses in conjunction with the Resources Conservation and Recovery Act (RCRA) and CERCLA (Superfund) legislation, as well as requirements set forth by the National Pollution Discharge Elimination System (NPDES) and Oregon’s DEQ. Other methods and analyses are also available upon request.

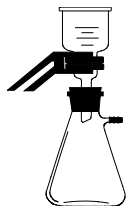

Coliforms

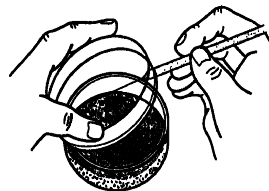

Total Coliforms / Fecal Coliforms	Method	Price
Colilert (Total Coliform & <i>E. coli</i>) MPN.....	SM 9223B Quantitray	\$44
15 Tube MPN (3 Dilutions) (Total & Fecal).....	SM 9221A,B,C,E	\$56
35 Tube MPN (7 Dilutions) for Fecal Sludge.....	SM 9221A,B,C,E	\$80
Membrane Filter Method	SM 9222A & B	\$60
Fecal <i>Enterococci</i> MPN (Quantitray®).....	SM 9223B	\$58



Environmental SOCs (GCMS)

Semivolatile Organics (EPA 8270/625).....	Quote		
Acenaphthene	Butylbenzylphthalate	4,6-Dinitro-2-methylphenol	4-Methylphenol
Acenaphthylene	2-Chloronaphthalene	2,4-Dinitrophenol	Naphthalene
Anthracene	4-Chloro-3-methylphenol	2,4-Dinitrotoluene	Nitrobenzene
Azobenzene	2-Chlorophenol	2,6-Dinitrotoluene	2-Nitrophenol
Benzidine	Chrysene	Di- <i>n</i> -butylphthalate	4-Nitrophenol
Benzoic acid	4-Chlorophenyl-phenyl ether	1,2-Diphenylhydrazine	N-Nitrosodi- <i>n</i> -propylamine
Benzo(a)anthracene	<i>o</i> -Dichlorobenzene	Di- <i>n</i> -octylphthalate	N-Nitrosodiphenylamine
Benzo(b)fluoranthene	<i>m</i> -Dichlorobenzene	Fluoranthene	N-Nitrosodimethylamine
Benzo(k)fluoranthene	<i>p</i> -Dichlorobenzene	Fluorene	Pentachlorophenol
Benzo(g,h,i)perylene	Dibenzo(a,h)anthracene	Hexachloroethane	Phenanthrene
Benzo(a)pyrene	3,3'-Dichlorobenzidine	Hexachlorobutadiene	Phenol
Bis(2-chloroethyl)ether	2,4-Dichlorophenol	Hexachlorocyclopentadiene	Pyrene
Bis(2-chloroethoxy)methane	2,6-Dichlorophenol	Hexachlorobenzene	2,3,4,6-Tetrachlorophenol
Bis(2-chloro-isopropyl)ether	Diethylphthalate	Indeno(1,2,3-cd)pyrene	1,2,4-Trichlorobenzene
Bis(2-ethylhexyl)phthalate	2,4-Dimethylphenol	Isophorone	2,4,5-Trichlorophenol
4-Bromophenyl-phenyl ether	Dimethylphthalate	2-Methylphenol	2,4,6-Trichlorophenol

Phenols (EPA 8270/625)..... \$245

Benzoic acid	4,6-Dinitro- <i>o</i> -cresol	Pentachlorophenol
4-Chloro-3-methylphenol	2,4-Dinitrophenol	Phenol
2-Chlorophenol	2-Methylphenol	2,4,5-Trichlorophenol
2,4-Dichlorophenol	4-Methylphenol	2,4,6-Trichlorophenol
2,6-Dichlorophenol	2-Nitrophenol	2,3,4,6-Tetrachlorophenol
2,4-Dimethylphenol	4-Nitrophenol	

Polynuclear Aromatic Hydrocarbons (PAHs-EPA 8270/625)..... \$245

Acenaphthene	Benzo(g,h,i)perylene	Indeno(1,2,3-cd)pyrene
Acenaphthylene	Benzo(k)fluoranthene	Naphthalene
Anthracene	Chrysene	Phenanthrene
Benzo(a)anthracene	Dibenzo(a,h)anthracene	Pyrene
Benzo(a)pyrene	Fluoranthene	
Benzo(b)fluoranthene	Fluorene	

Polychlorinated Biphenyls (PCBs - EPA 8082/608) \$195

Polychlorinated Biphenyls (PCBs) - Transformer Oil (EPA 9079) \$105

Phthalate Esters (EPA 8270/625) \$225

Benzybutylphthalate	Di- <i>n</i> -butylphthalate	Dimethylphthalate
Bis(2-ethylhexyl)phthalate	Diethylphthalate	Di- <i>n</i> -octylphthalate

Organochlorine Pesticides (EPA 8081) \$215

Aldrin	Chlordane (α and γ)	Endosulfan I	Heptachlor
α -BHC	4,4'-DDD	Endosulfan II	Endrin ketone
β -BHC	4,4'-DDE	Endosulfan sulfate	Heptachlor epoxide
δ -BHC	4,4'-DDT	Endrin	Methoxychlor
γ -BHC (Lindane)	Dieldrin	Endrin aldehyde	Toxaphene

Organochlorine Pesticides and PCBs Combined (EPA 8081+8082) \$245

Organophosphorus Pesticides (EPA 8141) \$285

Azinphos methyl (Guthion)	Dichlorvos	Naled
Bolstar	Disulfoton	Methyl parathion
Chlorpyrifos	Ethoprop	Phorate
Coumaphos	Fensulfothion	Ronnel
Demeton-O	Fenthion	Stirophos
Demeton-S	Merphos	Tokuthion
Diazinon	Mevinphos	Trichloronate

Chlorinated Herbicides (EPA 615/8151) \$235

2,4-D	Dalapon	Pentachlorophenol
2,4,5-T	Dicamba	
2,4,5-TP (Silvex)	Dinoseb	

Single, Non-Listed Pesticide Quote

Single Listed Herbicide, Pesticide, or Semi-Volatile \$175

Single, Non-Listed Herbicide Quote

Extraction of Herbicides from Soils \$90

Extraction of Pesticides from Soils \$45

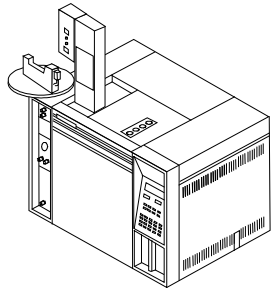

Volatile Organics

Volatile Organics (EPA 8260/624) \$285

Acetone	2-Chlorotoluene	1,3-Dichloropropane	Tetrachloroethylene
Acrylonitrile	4-Chlorotoluene	2,2-Dichloropropane	Toluene
Benzene	Dibromochloromethane	1,1-Dichloropropene	1,2,3-Trichlorobenzene
Bromobenzene	1,2-Dibromo-3-chloropropane	<i>cis</i> -1,3-Dichloropropene	1,2,4-Trichlorobenzene
Bromochloromethane	1,2-Dibromoethane	<i>trans</i> -1,3-Dichloropropene	1,1,1-Trichloroethane
Bromodichloromethane	Dibromomethane	Ethylbenzene	1,1,2-Trichloroethane
Bromoform	1,2-Dichlorobenzene	Hexachlorobutadiene	Trichloroethylene
Bromomethane	1,3-Dichlorobenzene	Isopropylbenzene	Trichlorofluoromethane
<i>n</i> -Butylbenzene	1,4-Dichlorobenzene	4-Isopropyltoluene	1,2,3-Trichloropropane
<i>sec</i> -Butylbenzene	1,1-Dichloroethane	Methylene chloride	1,3,5-Trimethylbenzene
<i>tert</i> -Butylbenzene	1,2-Dichloroethane	Methyl ethyl ketone	1,2,4-Trimethylbenzene
Carbon tetrachloride	1,1-Dichloroethylene	Naphthalene	Vinyl chloride
Chlorobenzene	<i>cis</i> -1,2-Dichloroethylene	<i>n</i> -Propylbenzene	<i>m,p</i> -Xylene
Chloroethane	<i>trans</i> -1,2-Dichloroethylene	Styrene	<i>o</i> -Xylene
Chloroform	Dichlorodifluoromethane	1,1,1,2-Tetrachloroethane	Total Xylenes
Chloromethane	1,2-Dichloropropane	1,1,2,2-Tetrachloroethane	

Halogenated Volatile Organics (EPA 8260/624) \$245

Benzyl chloride	Chloroethane	<i>o</i> -Dichlorobenzene	1,1,1,2-Tetrachloroethane
Bis(2-chloroethoxy)methane	Chloroform	<i>p</i> -Dichlorobenzene	1,1,2,2-Tetrachloroethane
Bis(2-chloroisopropyl)ether	1-Chlorohexane	Dichlorodifluoromethane	Tetrachloroethylene
Bromobenzene	2-Chloroethyl vinyl ether	1,1-Dichloroethane	1,1,1-Trichloroethane
Bromodichloromethane	Chloromethane	1,2-Dichloroethane	1,1,2-Trichloroethane
Bromoform	Chloromethyl methyl ether	1,1-Dichloroethylene	Trichloroethylene
Bromomethane	Chlorotoluene	<i>trans</i> -1,2-Dichloroethylene	Trichlorofluoromethane
Carbon tetrachloride	Dibromochloromethane	Dichloromethane	Trichloropropane
Chloroacetaldehyde	Dibromomethane	1,2-Dichloropropane	Vinyl chloride
Chlorobenzene	<i>m</i> -Dichlorobenzene	<i>trans</i> -1,3-Dichloropropylene	

BTEX-Water only (EPA 8260): Benzene, Toluene, Ethylbenzene, Xylenes \$120

Underground Storage Tank (UST) Fuel Residue

Hydrocarbon Identification	OR-DEQ NWTPH-HCID.....	\$75
Quantitation: Gasoline	OR-DEQ NWTPH-Gx	\$120
Quantitation: Diesel (Water)	OR-DEQ NWTPH-Dx	\$139
Quantitation: Bunker C, Lube Oils	OR-DEQ Ext NWTPH-Dx.....	\$139
Light Aromatics-Soil (BTEX/TPH-G).....	EPA 8021B.....	\$120
Hydrocarbon Identification with Quantitation		\$169

Storm Water Runoff Services

Call our office with your permit information, and we will provide a competitive quote tailored to your specific project needs.

Miscellaneous Testing

Bottled Water Analysis Package..... \$3190

Coliform-MPN	Ortho-Phosphate	Radium 226/228
Total Phenolics	Haloacetic Acids	Uranium
IOC, SOC, VOC	Bromate	Chlorine
Oregon Secondary	Chlorite	Chloramine
Turbidity	Gross Alpha	Chlorine dioxide
Potassium	Gross Beta	

Distilled Water Metals (Micro Lab Use): Cadmium, Chromium, Copper, Lead, Nickel, Zinc \$130

Water Suitability (Micro Lab Use)..... \$285

Sludge Analysis (EPA 3050B) \$390

Arsenic	Nitrogen (Total Kjeldahl, Ammonia, Nitrate, and Nitrite)	Potassium
Cadmium	Mercury	Selenium
Chromium	Molybdenum	Zinc
Copper	pH	Total Solids
Lead	Total Phosphorus	Volatile Solids (as % TS)
Nickel		

Toxic Characteristic Leaching Procedure (TCLP) EPA 1311

Metals & Non-volatiles Extraction..... EPA 1311.....	\$130
Zero Headspace Extraction..... EPA 1311.....	\$170
RCRA Metals Analysis: As, Ba, Cd, Cr, Pb, Hg, Se, Ag..... EPA 200.8.....	\$205
Special sample preparation charge (grinding, pulverizing, etc.)	Quote

Sampling, Preparation, Cleanup & Miscellaneous

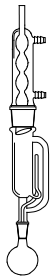

Sample Collection Fee: \$0.60/Mile + Time @ \$60/Hr	
Acid Digestion (Water)	\$20
Acid Digestion (Soil, Sludge, and Solids)	\$45
Heat of Combustion (Bomb Calorimetry).....	\$120
Fluorosil, Silica Gel, or Alumina Column Cleanup.....	\$20
Extraction of Herbicides from Soil	\$90
Extraction of Pesticides from Soil	\$45
Composite Fee.....	\$45

Inorganic Contaminants

With a few exceptions, inorganic contaminants are detected individually. Custom packages of inorganic analyses are usually required to fit the individual needs of the NPDES permittee, or to fit the history of the contaminated site requiring characterization. The Individual Analyte Price List (page 1) summarizes tests available for individual inorganics. *Please contact the laboratory for price quotations on custom analytical packages to meet your unique requirements.*

Rush Analysis Rates

We can provide expedited results for most analyses. Please contact the laboratory with your specific needs, and we will provide a quoted price for the required turn-around-time.

NOTE: Turn-a-round times are working days and begin upon arrival of sample at the laboratory

CALL LAB PRIOR TO SENDING SAMPLES

NORMAL TURN-AROUND-TIME:

3 days for Coliforms, 5 days for Nitrate
5-10 working days for most individual tests
10-15 working days for SOCs, IOCs, and environmental analyses

**Quantity Discounts are Available
for Most Services**

*Contact the Laboratory
For a Price Quote*

Special Lab & Field Consulting and Non-routine Analyses

Direct Expenses.....	COST + 15%
Principal	\$185.00/Hr
Professional	\$105.00/Hr
Lab Technician.....	\$60.00/Hr
Mileage.....	\$0.60/Mile
Other testing needs not listed	Quote

Courier services are available. Call for route and pricing information.

Quality Assurance/Quality Control

Our Quality Assurance Officer (QAO), who operates independently and reports directly to top management, ensures that good laboratory practices are integrated into all aspects of operations at URC Analytical Services. Quality Control (QC) is built into our current Laboratory Information Management System (LIMS) and thoroughly documented in each standard operating procedure (SOP) and analytical instrumentation monitoring system. Corrective action is well documented for any deficiency observed and action is taken immediately to eliminate the source of error. QC and analytical procedures are detailed in the laboratory's QA Manual and in the Laboratory SOP Manual. These established protocols exceed those mandated by the EPA for laboratory practices.

Instrumentation

- Gas Chromatograph / Mass Spectrometer (GCMS) – 6890GC/5973MSD and 7890GC/5975MSD
- Tekmar Atomx Purge & Trap for GC/MS
- Additional Gas Chromatographs with FID, ECD, and PID
- Agilent 7500C ICP-MS
- Atomic Absorption Spectrophotometer with flame, cold-vapor, and graphite furnace capabilities
- Photodiode Array (PDA) UV/Vis Spectrophotometer
- Total Organic Carbon (TOC) Analyzer
- High Performance Liquid Chromatograph (HPLC) with PDA UV and Fluorescence Detectors
- Ion Chromatograph HPLC System
- A full complement of general analytical laboratory equipment

SPECIAL NOTES: We cannot be responsible for holding times that are exceeded for samples delivered on weekends or after 5 p.m. on weekdays without prior notification and approval. Please call the lab if you are unsure about special containers or sampling procedures. Prices and methods are subject to change without notice.

In Case of Emergency or After Business Hours Call

Myrtle Creek

Lisa Leming
Office Manager
Office: (541) 863-5201
Cell: (541) 863-2662

Bend

Dan Phillips
Laboratory Manager
Office: (541) 312-9455
Cell: (541) 863-2662

Municipal Water Suppliers: Please call during normal office hours for a listing of private telephone numbers to include in your security plan.